

Product Highlights

- The SL1236 is characterized as a Large Aimed Spot Light.
- Precisely aimed LEDs provide a level of lighting control not found in traditional illuminators.
- A range of standoffs and fields of view may be specified at the time of order.



General Specifications

Electrical Specifications	Color	24V Current	All Other Controls
	625, 660	0.18A	0.09A Max
	880	0.18A	0.07A Max
	395, 470, 520, WHI, RGB	0.12A	0.11A Max
Normal Operating Temperature	0 - 60°C		
Weight	90.7g (3.2oz)		
Standard Cable Information	2 m long -0/+150 mm (80" -0/+6") - 105°C rated PVC jacket, foil shield with drain.		
Photobiological Risk Factor	Exempt Applicable Wavelengths: 880 Group 1 (Low-Risk) Applicable Wavelengths: 470, 520, 625, 660, WHI, RGB Group 2 (Moderate-Risk) Applicable Wavelengths: 395		
Compliance	CE, RoHS, IEC 62471		
IP Rating	IP50		
Lumen Maintenance	L70 = 50,000 Hours		

Part Number Key

Model	—	Peak Wavelength	Stand Off (mm)	Illuminated Field of View (mm)	Connector/Control	Light Conditioning Option	—	Alternative Connector
SL1236	—	XXX	XXX	XX	X	X	—	XXX
SL1236		395 (UV)	See chart to compute stand off	XS	C1	D		M8 ¹
		470 (blue)		S	C5	(Diffuser)		M12 ¹
		520 (green)		M	IC	P ³		
		625 (red orange)		L	I3	(Polarizer)		
		660 (red)		XL	I3S			
		880 (IR)			24			
		WHI (white)						
		RGB (all colors) ²						
EX:								
SL1236-395100SC5D	¹ Available with IC, I3, I3S, and 24 V options only							
SL1236-625150XL13P-M8	² Available in C1 and 24 V options only							
	³ Not available with UV option; 470 (blue) will reduce the life of the polarizer							

See website product page for in-stock product numbers.

Shipping:

Stock Products: within three days

Build-to-Order Products: within one to three weeks

Mechanical Specs

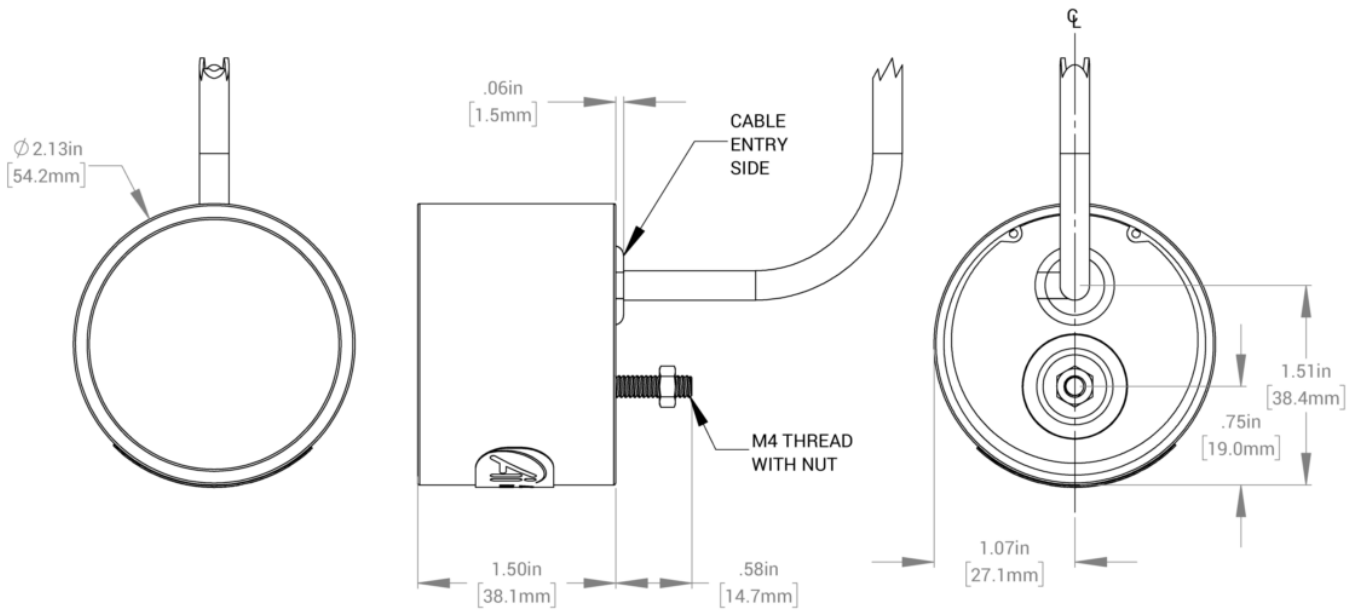

Intensity Distribution

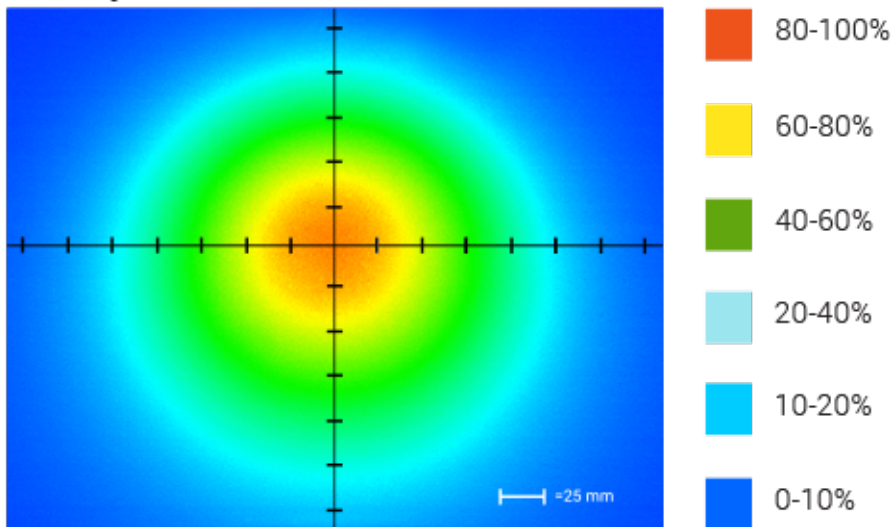

Optical measurement taken using SL1236-625200LIC

Area of Illuminance & Intensity

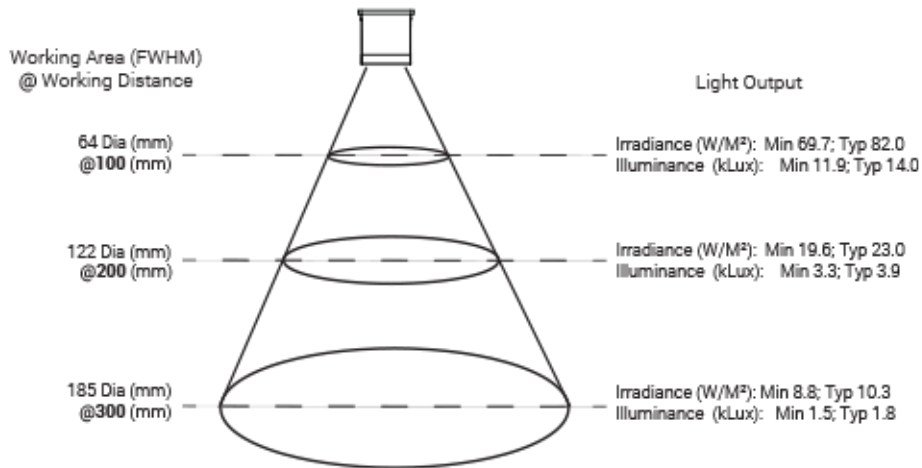

[FIELD OF VIEW CHART]

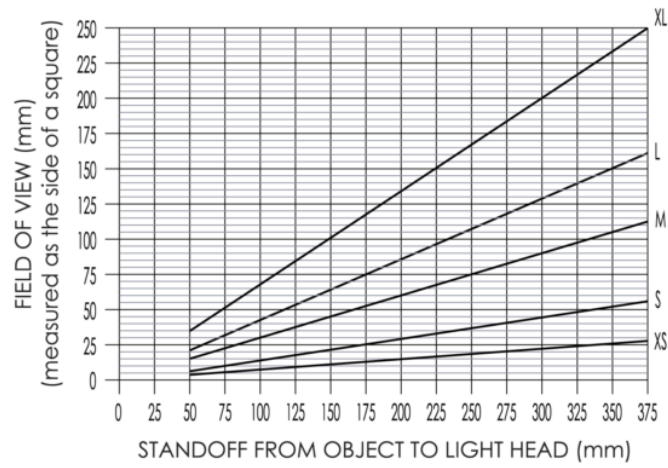
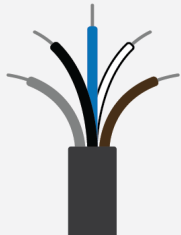

Figure 1

Identify desired FOV and standoff, then specify nearest illuminated area size

Standard Flying Lead Functions for 24V, IC, I3 and I3S Control Options

	COLOR	24V FUNCTIONS	IC FUNCTIONS	I3/I3S FUNCTIONS
	BROWN	24 V DC	24 V DC	24 V DC
	WHITE	N/A	0-10 V ANALOG DIMMING	RESERVED
	BLUE	DC GND	DC GND	DC GND
	BLACK	N/A	PNP/ACTIVE LOW GATE	PNP/ACTIVE HIGH TRIGGER
	GRAY	N/A	N/A	0-10 V ANALOG DIMMING

The functions listed above are applicable when this product is configured with built-in 24V, IC, I3, or I3S control, **without** the optional A-coded 5-position Male M12 or A-coded 4-position Male M8 connector.

M12 Connector Pinout Functions for 24V, IC, I3 and I3S Control Options

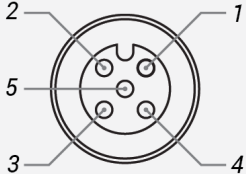
	PIN	24V FUNCTIONS	IC FUNCTIONS	I3/I3S FUNCTIONS
	1	24 V DC	24 V DC	24 V DC
	2	N/A	0-10 V ANALOG DIMMING	RESERVED
	3	DC GND	DC GND	DC GND
	4	N/A	PNP/ACTIVE LOW GATE	PNP/ACTIVE HIGH TRIGGER
	5	N/A	N/A	0-10 V ANALOG DIMMING

The functions listed above are only applicable when this product is configured with built-in 24V, IC, I3, or I3S control, **with** an A-coded 5-position Male M12 connector.

M8 Connector Pinout Functions for 24V, IC, I3 and I3S Control Options

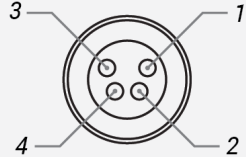
	PIN	24V FUNCTIONS	IC FUNCTIONS	I3/I3S FUNCTIONS
	1	24 V DC	24 V DC	24 V DC
	2	N/A	0-10 V ANALOG DIMMING	0-10 V ANALOG DIMMING
	3	DC GND	DC GND	DC GND
	4	N/A	PNP/ACTIVE LOW GATE	PNP/ACTIVE HIGH TRIGGER

The functions listed above are only applicable when this product is configured with built-in 24V, IC, I3, or I3S control, **with** an A-coded 4-position Male M8 connector.

For details on operating configurations without built-in control (C1, C5, Q1, and Q4 control, when available), please refer to Advanced illumination's controller manuals.

Control Specs

C1 Connector	C5 Connector	ICS 2 (IC)	ICS 3 (I3)	ICS 3S (I3S)	24
For use with: DCS Series Controllers	For use with: Pulsar 320 Strobe Controller.	Continuous in-line controller Powered with: 24V power supply	Combination strobe/continuous in-line controller Powered with: 24V power supply	Default-OFF strobe/continuous in-line controller Powered with: 24V power supply	Flying/tinned leads Powered with: 24V power supply

Warranty Information

Every Advanced illumination, Inc. (Ai) product is thoroughly inspected and tested before leaving the factory. Products are warranted to be free of defects in workmanship and materials for a period of FIVE YEARS from the original date of purchase. Should a defect develop during this period, customers may return the complete product, freight prepaid, to one of Ai's distributors or to the Ai factory. All product warranty returns require a Return Merchandise Authorization (RMA) number which is obtained from Customer Service. The RMA number must be clearly marked on the outside of the package. Ai will inspect the unit, and if a defect is found will, at our option, repair or replace the product without charge. Ai disclaims liability for any implied warranties, including implied warranties of "merchantability" and "fitness for a specific purpose." For products under warranty that have since been discontinued, Ai will make an effort to replace with equivalent parts; for circumstances that do not allow for equivalent replacement, Ai reserves the right to repair or replace these products with an updated version. Ai cannot be held responsible for the unauthorized or inappropriate use of its products. Any unauthorized repair or modifications will result in a voided warranty.

No Liability for Consequential Damages: In no event shall Ai be liable for any consequential, special, incidental, or indirect damages of any kind arising from the sale or use of the products.

Electromagnetic Compatibility

This product was tested and complies with the regulatory requirements and limits for electromagnetic compatibility (EMC) as stated in the product specifications. These requirements and limits are designed to provide reasonable protection against harmful interference only when the product is operated in its intended industrial electromagnetic environment. To minimize the potential for electromagnetic interference or unacceptable performance degradation, install and use this product in strict accordance with the instructions in the product documentation.

Customer Service

For information on existing orders, or to make an order adjustment, contact us Monday through Friday 8:00 am to 5:00 pm ET or send an email to orders@advancedillumination.com.

Company Information

Advanced Illumination

440 State Garage Road, Rochester, VT 05767

Phone: 802.767.3830

Fax: 802.767.2636

Email: info@advancedillumination.com

Web: advancedillumination.com

© 2021 Advanced illumination Inc. All rights reserved