

Voltage / Current Breakout Test Boxes

NXB20815



NXB12020A



NXB12020



NXB20830



NXB20820S



NXB20820



Ideal for lab situations requiring simultaneous, real-time, voltage and current monitoring. All models have extra long power cord and non-skid feet for stability making this the ideal accessory for your lab.

Quick Selection Guide

Model #	Voltage	Current	Input	Output	Test Output	Switch/Breaker
NXB12020	120/240	20A	AC Line - Cord	5-20R (2)	Bannana Leads	No
NXB12020A	120/240	20A	AC Line - Cord	5-20R (4)	Pigtail	Yes
NXB12030	120	30A	L5-30 - Cord	L5-30R	Pigtail	Yes
NXB20815	208	15A	C14 Inlet	IEC C-13 (8)	Pigtail	Yes
NXB20820	208	20A	L6-20 - Cord	L6-20R	Pigtail	Yes
NXB20830	208	30A	L6-30 - Cord	L6-30R	Pigtail	Yes
NXB20820S	208	20A	C14	C13	Pigtail	No
NXB12020B	120/240	20A	C14 Inlet	Universal	Pigtail	Yes

13716 457th Avenue SE • North Bend • WA • 98045

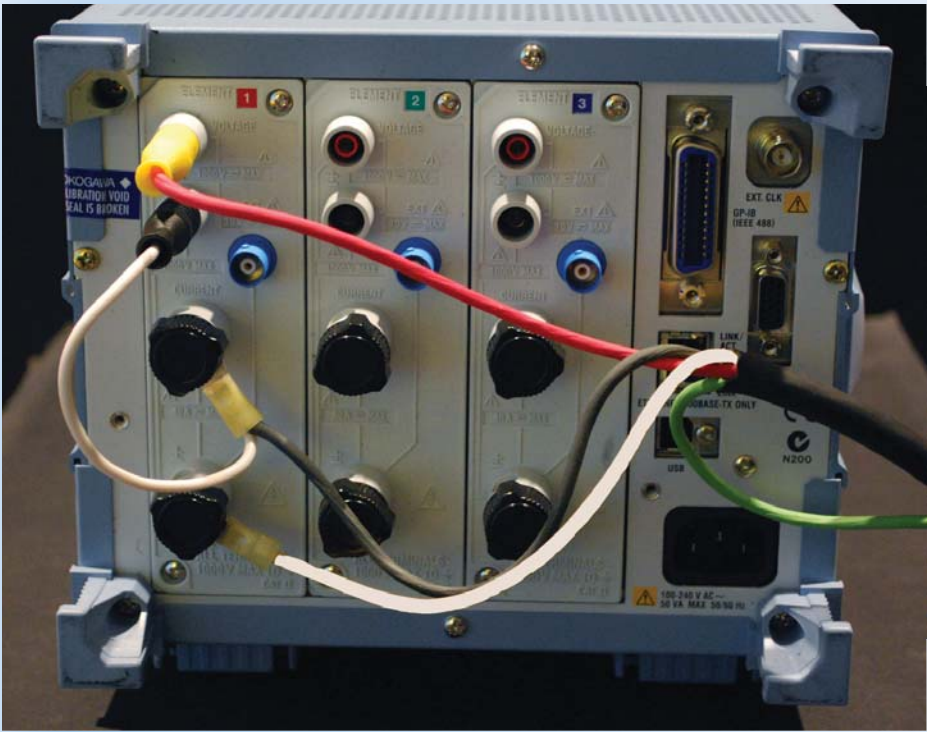

neoXT - WT500 Connections



Pigtail Assembly for meter connections

neoXT Breakout Box - Circuit Diagram

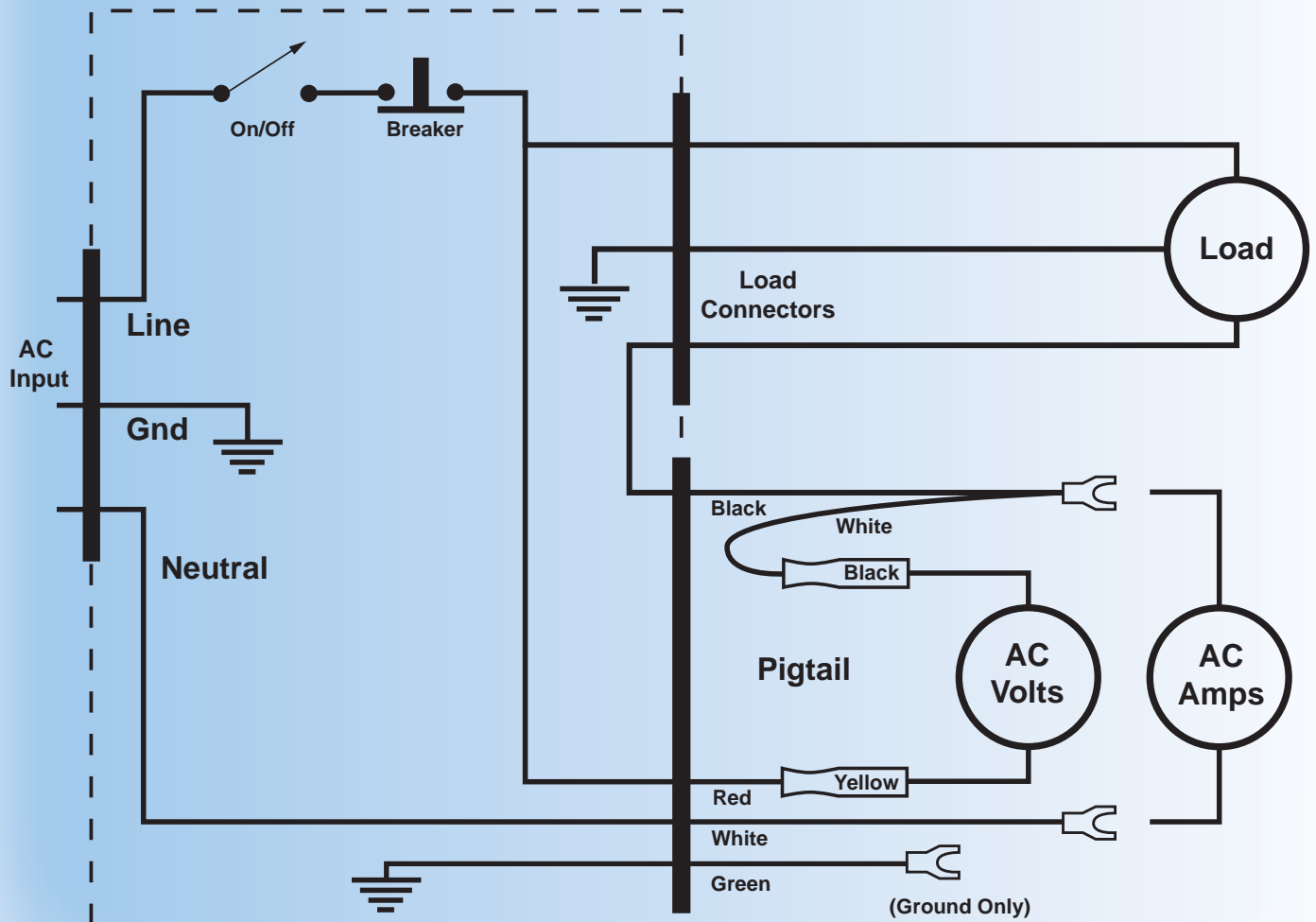

Figure 4

neoXt
NXB 12020

Voltage / Current Breakout Test Boxes



All components are rated for 208 VAC Nominal, 250 VAC Max at 20A. Banana plugs for voltage and current provide maximum flexibility for connecting to test gear. Banana plugs are safety shrouded for user safety.

NXB 12020 Specifications

- Two 120/240 V Outlets
- Circuitry rated for 20 A
- 8' Flexible Power Cord
- Shrouded Safety Banana Jacks
- Stable footprint with non-slip feet

Accessories

NXB 12020-2YB-60 2 pair 60" yellow/black cables with shrouded banana jacks and removable #8 fork lug terminals



13716 457th Avenue SE • North Bend • WA • 98045

Distributed by PSI Solutions

www.psirep.com



sales@psirep.com

253-838-9263

neoXt
NXB 12020A

Voltage / Current Breakout Test Boxes



Multiple outlets provide flexibility in connecting equipment under test. Tester pigtail interface simplifies connecting to a variety of voltage/current measuring systems.

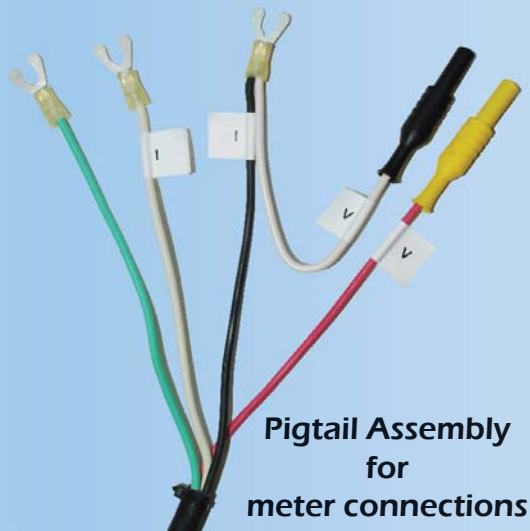

NXB 12020A Specifications

- On-Off power switch
- 20 A Circuit Breaker
- 8' Flexible Power Cord
- Outlets – (4) 5-20R
- Test Tap:
 - 3ft.
 - (2) fork terminals (current)
 - (1) fork terminals (ground)
 - (2) Shielded Banana (voltage)

13716 457th Avenue SE • North Bend • WA • 98045

Distributed by PSI Solutions

www.psirep.com



sales@psirep.com

253-838-9263

neoXt

NXB 12020B

Voltage / Current Breakout Test Boxes



Multiple outlets provide flexibility in connecting equipment under test. Tester pigtail interface simplifies connecting to a variety of voltage/current measuring systems.

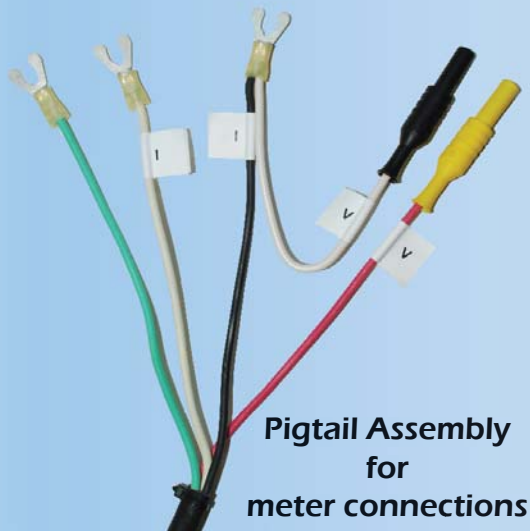

**Pigtail Assembly
for
meter connections**

NXB 12020B Specifications

- On-Off power switch
- 20 A Circuit Breaker
- Outlets – (2) Universal
- Test Tap:
 - 3ft.
 - (2) fork terminals (current)
 - (1) fork terminals (ground)
 - (2) Shielded Banana (voltage)

13716 457th Avenue SE • North Bend • WA • 98045

Distributed by PSI Solutions

www.psirep.com



sales@psirep.com

253-838-9263

neoXt
NXB 12030

Voltage / Current Breakout Test Boxes



Single output for passthrough to test rack. Tester pigtail interface simplifies connecting to a variety of voltage/current measuring systems.

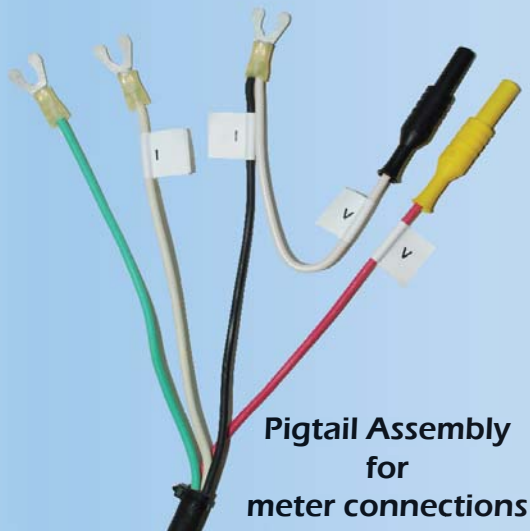

**Pigtail Assembly
for
meter connections**

NXB 12030 Specifications

- On-Off power switch
- 30 A Circuit Breaker
- Inlet - NEMA L5-30
- Outlets – NEMA L5-30R
- Test Tap:
 - 3ft.
 - (2) fork terminals (current)
 - (1) fork terminals (ground)
 - (2) Shielded Banana (voltage)

13716 457th Avenue SE • North Bend • WA • 98045

Distributed by PSI Solutions

www.psirep.com



sales@psirep.com

253-838-9263

Voltage / Current Breakout Test Boxes



Multiple outlets provide flexibility in connecting equipment under test. Tester pigtail interface simplifies connecting to a variety of voltage/current measuring systems.

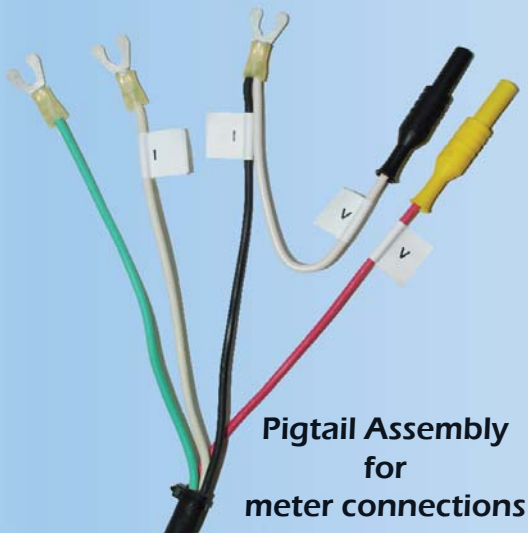

**Pigtail Assembly
for
meter connections**

NXB 20815 Specifications

- On-Off power switch
- 20 A Circuit Breaker
- Inlet - IEC C14 for use with any cordset
- Outlets – (8) IEC C13
- Test Tap:
 - 3ft.
 - (2) fork terminals (current)
 - (1) fork terminals (ground)
 - (2) Shielded Banana (voltage)

13716 457th Avenue SE • North Bend • WA • 98045

neoXt
NXB 20820

Voltage / Current Breakout Test Boxes



Single output for passthrough to test rack. Tester pigtail interface simplifies connecting to a variety of voltage/current measuring systems.

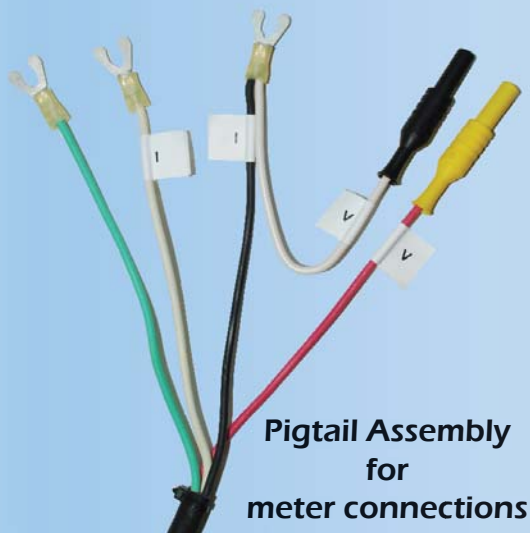

NXB 20820 Specifications

- On-Off power switch
- 20 A Circuit Breaker
- Inlet - NEMA L6-20
- Outlets – NEMA L6-20R
- Test Tap:
 - 3ft.
 - (2) fork terminals (current)
 - (1) fork terminals (ground)
 - (2) Shielded Banana (voltage)

13716 457th Avenue SE • North Bend • WA • 98045

Distributed by PSI Solutions

www.psirep.com



sales@psirep.com

253-838-9263

neoXt
NXB 20830

Voltage / Current Breakout Test Boxes



Single output for passthrough to test rack. Tester pigtail interface simplifies connecting to a variety of voltage/current measuring systems.

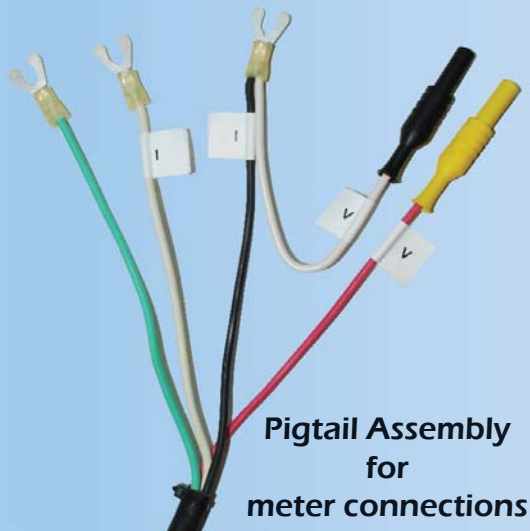

**Pigtail Assembly
for
meter connections**

NXB 20830 Specifications

- On-Off power switch
- 30 A Circuit Breaker
- Inlet - NEMA L6-30
- Outlets – NEMA L6-30R
- Test Tap:
 - 3ft.
 - (2) fork terminals (current)
 - (1) fork terminals (ground)
 - (2) Shielded Banana (voltage)

13716 457th Avenue SE • North Bend • WA • 98045

Distributed by PSI Solutions

www.psirep.com



sales@psirep.com

253-838-9263

neoXt
NXB 20820S

Voltage / Current Breakout Test Cable



Simple single input output (IEC C13/C14) connection with pigtail tap for connecting to power meter.

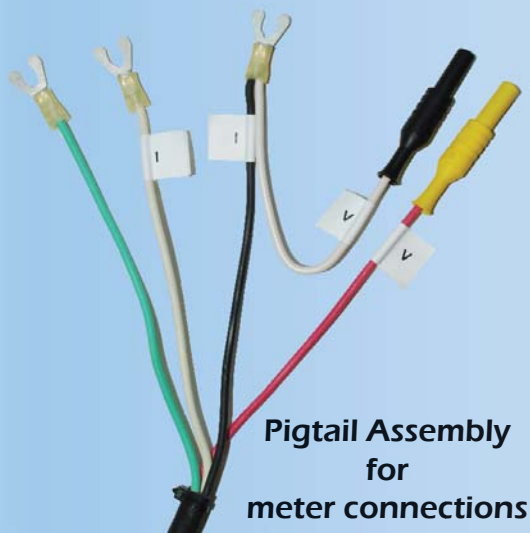

**Pigtail Assembly
for
meter connections**

NXB 20820S Specifications

- 15' Flexible Power Cord
- IEC C13 / C14 Connectors
- Test Tap:
 - 3ft.
 - (2) fork terminals (current)
 - (1) fork terminals (ground)
 - (2) Shielded Banana (voltage)

13716 457th Avenue SE • North Bend • WA • 98045

Distributed by PSI Solutions

www.psirep.com



sales@psirep.com

253-838-9263